



TIC 300 PRO

High Energy Tic Tracer –

**Non Contact
AC Voltage Detector**

Users Manual

- Mode d'emploi
- Bedienungshandbuch
- Manual d'uso
- Manual de uso



TIC 300 PRO

High Energy Tic Tracer –

Non Contact

AC Voltage Detector

Users Manual

March 2010, Rev002
©2010 Amprobe Test Tools.
All rights reserved. Printed in China

English

Limited Warranty and Limitation of Liability

Your Amprobe product will be free from defects in material and workmanship for 1 year from the date of purchase. This warranty does not cover fuses, disposable batteries or damage from accident, neglect, misuse, alteration, contamination, or abnormal conditions of operation or handling. Resellers are not authorized to extend any other warranty on Amprobe's behalf. To obtain service during the warranty period, return the product with proof of purchase to an authorized Amprobe Test Tools Service Center or to an Amprobe dealer or distributor. See Repair Section for details. THIS WARRANTY IS YOUR ONLY REMEDY. ALL OTHER WARRANTIES - WHETHER EXPRESS, IMPLIED OR STATUTORY - INCLUDING IMPLIED WARRANTIES OF FITNESS FOR A PARTICULAR PURPOSE OR MERCHANTABILITY, ARE HEREBY DISCLAIMED. MANUFACTURER SHALL NOT BE LIABLE FOR ANY SPECIAL, INDIRECT, INCIDENTAL OR CONSEQUENTIAL DAMAGES OR LOSSES, ARISING FROM ANY CAUSE OR THEORY. Since some states or countries do not allow the exclusion or limitation of an implied warranty or of incidental or consequential damages, this limitation of liability may not apply to you.

Repair

All test tools returned for warranty or non-warranty repair or for calibration should be accompanied by the following: your name, company's name, address, telephone number, and proof of purchase. Additionally, please include a brief description of the problem or the service requested and include the test leads with the meter. Non-warranty repair or replacement charges should be remitted in the form of a check, a money order, credit card with expiration date, or a purchase order made payable to Amprobe® Test Tools.

In-Warranty Repairs and Replacement – All Countries

Please read the warranty statement and check your battery before requesting repair. During the warranty period any defective test tool can be returned to your Amprobe® Test Tools distributor for an exchange for the same or like product. Please check the "Where to Buy" section on www.amprobe.com for a list of distributors near you. Additionally, in the United States and Canada In-Warranty repair and replacement units can also be sent to a Amprobe® Test Tools Service Center (see address below).

Non-Warranty Repairs and Replacement – US and Canada

Non-warranty repairs in the United States and Canada should be sent to a Amprobe® Test Tools Service Center. Call Amprobe® Test Tools or inquire at your point of purchase for current repair and replacement rates.

In USA

Amprobe Test Tools

Everett, WA 98203

Tel: 877-AMPROBE (267-7623)

In Canada

Amprobe Test Tools

Mississauga, ON L4Z 1X9

Tel: 905-890-7600

Non-Warranty Repairs and Replacement – Europe

European non-warranty units can be replaced by your Amprobe® Test Tools distributor for a nominal charge. Please check the "Where to Buy" section on www.amprobe.com for a list of distributors near you.

European Correspondence Address*

Amprobe® Test Tools Europe

In den Engematten 14

79286 Glottertal, Germany

Tel.: +49 (0) 7684 8009 - 0

*(Correspondence only – no repair or replacement available from this address. European customers please contact your distributor.)

TIC 300 PRO

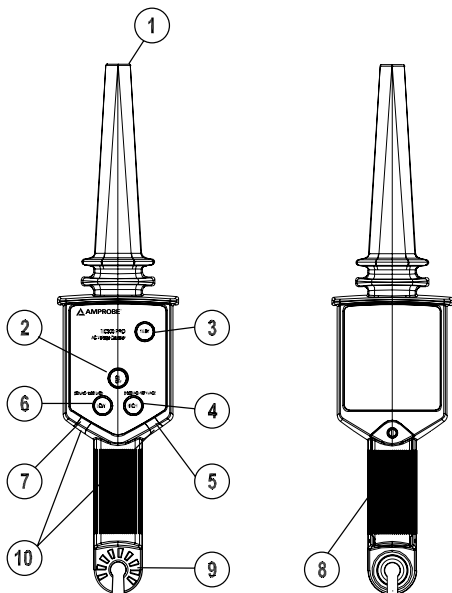

1) Voltage sensor

2) ON/OFF Button

3) Circuit TEST button

4) HIGH range switch

5) HIGH range LED

6) LOW range switch

7) LOW range LED

8) Battery compartment







9) HOT STICK attachment point

10) Detection Blue LEDs indicator

CONTENTS

SYMBOLS	2
UNPACKING AND INSPECTION	3
INTRODUCTION	4
Features	4
OPERATION	5
ON / OFF Button	5
TEST Button	5
Voltage Detection	6
LOW Range.....	6
HIGH Range	6
Locate breaks in insulated wire & heating elements ..	7
Check Outlets and Switches	7
MAINTENANCE AND REPAIR	8
Battery Replacement	8
SPECIFICATION	9
LOW Voltage	10
HIGH Voltage.....	10

SYMBOLS

	Refer to the manual
	Caution Dangerous Voltage
	Double insulated
	Complies with EU directives
	Conforms to relevant Australian standards.
	Do not dispose of this product as unsorted municipal waste.

For Use By Trained Personnel Only

Anyone using this instrument should be knowledgeable and trained about the risks involved with measuring medium and high voltage, especially in an industrial setting, and the importance of taking safety precautions and of testing the instrument before and after using it to ensure that it is in good working condition.

⚠ *WARNING and PRECAUTIONS*

- Use extreme caution when testing live electrical circuits due to risk of injury from electrical shock.
- Do not exceed the maximum overload limits (see specifications) nor the limits marked on the instrument itself. Never test voltage more than 122 kV ac rms.
- When using the HIGH range, the TIC 410A HOT STICK or equivalent extension pole **MUST** be used.
- Comply with local and national safety requirements.
- Use proper protective equipment as required by local and national authorities.

- Observe the proper safety precautions when working with voltages above 33 VAC rms to avoid electrical shock hazard.
- Before and after hazardous voltage measurements, test the Tic 300 PRO by pressing the TEST button and/or on a known source such as line voltage to determine proper operation.
- Never ground yourself when taking measurements. Do not touch exposed circuit elements.
- Do not operate the instrument in an explosive atmosphere.
- Do not expose this product to rain or moisture. This increases the risk of fire or electric shock.
- Do not rely on this tester for shielded wire.
- Do not let the unit make contact with a live line with voltage higher than 20 kV.
- 3 phase feeder cables with conductors close to each other may self-cancel the electric field and not be detected by your Tic tracer. Verify that the phase conductors are separated by at least 15" (381mm) before testing for AC voltage.

UNPACKING AND INSPECTION

Your shipping carton should include:

- 1 TIC 300 PRO
- 1 9V Alkaline Battery
- 1 Users Manual
- 1 Carrying Case

If any of the items are damaged or missing, return the complete package to the place of purchase for an exchange.

INTRODUCTION

The TIC 300 PRO is an instrument for safely checking the presence of an AC voltage without making any disconnection in cables, wall sockets, fuses, circuit breakers, junction boxes, etc. No current flow is needed for correct operation.

Rugged and reliable for utility, industrial and mine safety applications, The TIC 300 PRO warns against dangerous voltages in low and medium voltage applications up to 122 KV without contacting the energized conductor.

Features

- Utility tool for checking transmission lines, power distribution equipment, down power lines, fuses, and load break connectors
- Lower voltage setting for checking voltage presence in breaker panels, breakers, power outlets and wiring
- Verifies presence of Voltage from 30 VAC to 122,000 VAC (122kV)
- Non-contact AC voltage detection
- Visual and audible voltage indication
- Self-test verifies that tester works properly
- Ergonomic design with a convenient handle
- Drop-proof to 6-FT

Used with Hot Stick TIC 410A for voltage higher than 1500V

OPERATION

ON / OFF Button

When the TIC 300 PRO is activated, the blue LED's and beeper will pulse at a slow rate about twice a second. The red LED of the range (HIGH) will turn ON.

TEST Button

The TEST button should be used prior to testing actual power circuits. The TEST function will cause the blue LEDs to pulse at a continuous rate and the beeper tone to stop either on LOW or HIGH mode.

OSHA listed clearance distances for working with voltage. National or local requirements may be different.

Line voltage (kV)	Phase to ground		Phase to phase	
	(ft-in)	(m)	(ft-in)	(m)
0.03 to 1.0	note1	note	note1	note1
1.1 to 15.0	2-1	0.64	2-2	.66
15.1 to 36.0	2-4	0.72	2-7	0.77
36.1 to 46.0	2-7	0.77	2-10	0.77
46.1 to 72.5	3-0	0.90	3-6	1.05
72.6 to 121	3-2	0.95	4-3	1.29

Note1. – No contact necessary

⚠ Caution: If a three phase circuit is being checked and one phase is open, the voltage from another phase maybe detected and will give a faulty indication. Always make sure that the phase cables are separated by at least 15" (381mm)

Voltage Detection

LOW Range

1. Push ON/OFF push button to turn the unit ON
2. The high voltage detection circuit is activated. A twice per second beep will be heard and the blue LEDs will flash at the same rate.
3. Push LOW range push button. The unit is ready for low voltage detection
4. Place the probe tip of the TIC 300 PRO near, but not touching the low (<1000 V) voltage line. See Fig.1
5. If voltage is present, the blue LEDs will blink at a faster rate and the beeper sound will increase at the same rate. A continuous visual rate without a beeper tone will register when the probe tip is too close to the voltage line.

HIGH Range (HOT STICK must be used)

(See Fig.5)

1. Push the HIGH range push button
2. Approach the probe tip near, but not touching the high voltage (> 1500 V and <122 kV) conductor.
3. If voltage is present, the blue LEDs will blink at a faster rate and the beeper sound will increase at the same rate. A continuous visual rate without a beeper tone will register when the probe tip is too close to the high voltage line.

Locate breaks in insulated wire and heating elements. (See Fig.2)

1. Push the ON/OFF push button to turn the unit on

2. Push the LOW range push button
3. Make sure the wire or the heating element is energized
4. Place the tip of the probe near the wire and start tracing along it. When the fast or continuous beep stops, this indicates the point of the break or "open"

Check Outlets and Switches. (See Figs 3 & 4)

1. Push the ON/OFF push button to turn the unit on
2. Push the LOW range push button
3. Place the probe tip of the TIC 300 PRO against the outlet or switch contact.
4. Increase beeping indicates voltage presence

MAINTENANCE AND REPAIR

If the TIC 300 PRO will not turn on, check the battery.

If there appears to be a malfunction during the operation of the voltage detector, the following steps should be performed in order to isolate the cause of the problem:

1. Check the battery.
2. Review the operating instructions for possible mistakes in operating procedure.

Except for the replacement of the battery, repair of the voltage detector should be performed only by a Factory Authorized Service Center or by other qualified instrument service personnel. The front panel and case can be cleaned with a mild solution of detergent and water. Apply sparingly with a soft cloth and allow drying completely before using. Do not use aromatic hydrocarbons or chlorinated solvents for cleaning.

Battery Replacement

Use phillips blade screwdriver to remove the battery hatch screw. Lift the hatch. Remove the battery and replace it with a 9 volt alkaline battery. Make sure the seal is in place. Close the battery hatch and replace the screw.

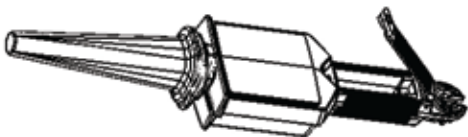

SPECIFICATION

Operating voltage

LOW Range: 30 to 1500 VAC; **HIGH Range:** 1500 VAC to 122 kVAC

Operating Temperature: 0°C to +52°C(32°F to +125°F);
RH < 90%

Storage Temperature:0°C to +52°C(32°F to +125°F)
battery removed.

Environment: < 2000m, outdoor operation

Power: 9 volt alkaline battery

Power Consumption:

- **OFF:** 340uA
- **Low Detection mode:** 39 mA
- **High Detection mode:**39 mA

Duty Cycle: Continuous

Response Time: Instantaneous

Dimensions: 345(L) x 75(W) x 47(H)mm (13.5 x 3.0 x 1.8 in)

Weight: 243g (0.5 lb.)

Optional Accessory: TIC 410A Hot Stick

CE EMC: EN 61326-1:2006 This product complies with requirements of the following European Community Directives: 2004/108/EC (Electromagnetic Compatibility) and 2006/95/EC (Low Voltage) as amended by 93/68/EEC (CE Marking). However, electrical noise or intense electromagnetic fields in the vicinity of the equipment may disturb the measurement circuit. Measuring instruments will also respond to unwanted signals that may be present within the measurement circuit. Users should exercise care and take appropriate precautions to avoid misleading results when making measurements in the presence of electronic interference.

Electrical:

Sensitivity: typical as listed on the table below

LOW Voltage

Voltage (Phase to Ground)	Detection Range
	Average
30V	2.7"
75V	9.7"
100V	1' 1"
120V	1' 6"
220V	2' 4"
500V	4' 2"
1000V	6' 3"
1500V	7' 9"

HIGH Voltage

Voltage (Phase to Ground)	Detection Range
	Average
1.5 kV	1' 2"
2.0 kV	2' 5"
4.0 kV	3"
10.0 kV	6' 3"
25.0 kV	9' 4"
50.0 kV	13' 0"
75.0 kV	14' 8"
100.0 kV	19' 8"
122.0 kV	22' 0"

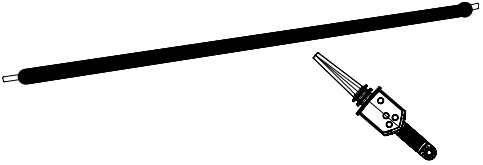

Fig.1 Voltage detection in a line

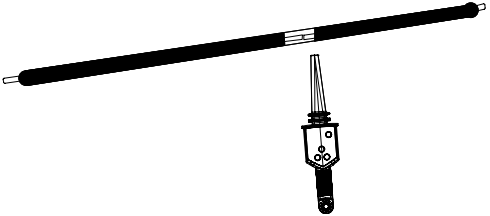

Fig.2 Finding a break or "open"

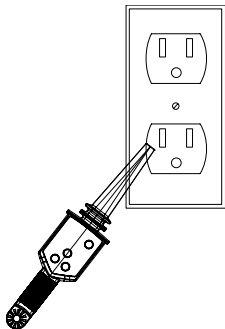

Fig.3 Voltage detection in a outlet

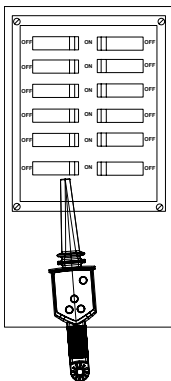

Fig.4 Finding a breaker

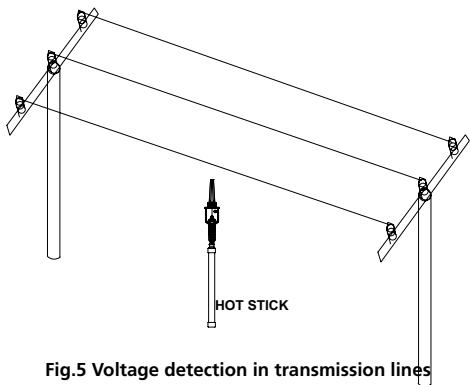

Fig.5 Voltage detection in transmission lines